

**OWNER'S MANUAL**

# **Model 10™**

AM/FM Clock Radio

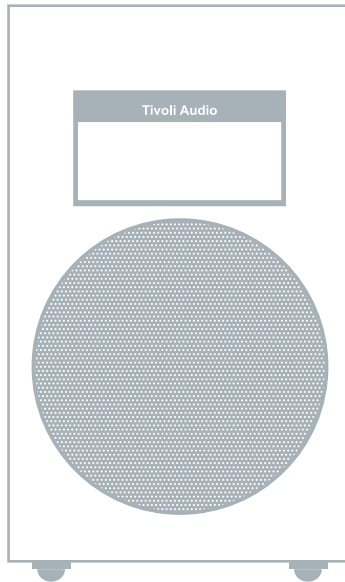

**Tivoli Audio®**



**Table of Contents:**

Safety Instructions..... 4

Introduction; About Tivoli Audio ..... 7

Front panel controls ..... 8

Rear panel controls ..... 9

Remote control..... 10

Mono/stereo setting; Menu; Adjust tone/EQ; Set the clock; Turn off the display ..... 11

How to set the alarm; Alarm options..... 12

FM/AM Reception; RDS/RBDS; Placement; Cleaning..... 13

Warranty ..... 14

Specifications ..... 15



This symbol is intended to alert the user to the presence of uninsulated “dangerous voltage” within the product’s enclosure that may be of sufficient magnitude to constitute a risk of electric shock to persons.



This symbol is intended to alert the user to the presence of important operating and maintenance (servicing) instructions in the literature accompanying the appliance.

## Important Safety Instructions

1. Read these instructions.
2. Keep these instructions.
3. Heed all warnings.
4. Follow all instructions.
5. Do not use this apparatus near water. For example, do not use near a bathtub, in a wet basement, near a swimming pool, and the like. **WARNING!** Do not expose this product to rain or moisture.
6. Clean only with a dry cloth.
7. Do not block any ventilation openings. Install in accordance with the manufacturer’s instructions.
8. Do not install near any heat sources such as radiators, heat registers, stoves, or other apparatus (including amplifiers) that produce heat.
9. Do not defeat the safety purpose of the polarized or grounding-type plug. A polarized plug has two blades with one wider than the other. A grounding type plug has two blades and a third grounding prong. The wide blade or the third prong are provided for your safety. If the provided plug does not fit into your outlet, consult an electrician for replacement of the obsolete outlet.
10. Protect the power cord from being walked on or pinched particularly at plugs, convenience receptacles, and the point where they exit from the apparatus.
11. Only use attachments/accessories specified by the manufacturer.
12. Use only with the cart, stand, tripod, bracket, or table specified by the manufacturer, or sold with the apparatus. When a cart is used, use caution when moving the cart/apparatus combination to avoid injury from tip-over.
13. Unplug this apparatus during lightning storms or when unused for long periods of time.



14. Refer all servicing to qualified service personnel. Servicing is required when the apparatus has been damaged in any way, such as power-supply cord or plug is damaged, liquid has been spilled or objects have fallen into the apparatus, the apparatus has been exposed to rain or moisture, does not operate normally, or has been dropped.
15. The radio must be located such that the rear AC socket and connected power cord are readily accessible.
16. This product has been tested and found to comply with the limits for Part 15 of the FCC rules. This device complies with Part 15 of the FCC Rules. Operation is subject to the condition that this device does not cause harmful interference. However, there is no guarantee that interference will not occur in a particular installation. If this equipment does cause harmful interference to radio or television reception, which can be determined by turning the product on and off, the user is encouraged to try to correct the interference by one or more of the following measures:
  - Reorient or relocate the receiving antennas.
  - Increase the separation between the equipment and the receiver.
  - Connect the equipment to an outlet on a circuit different from that to which the receiver is connected.
17. This Class B digital device complies with the Canadian ICES-003.
18. If an outside antenna or cable system is connected to the product, be sure the antenna or cable system is grounded so as to provide some protection against voltage surges and built-up static charges. Article 810 of the National Electrical Code, ANSI/NFPA 70, provides information with regard to proper grounding of the mast and supporting structure, grounding of the lead-in wire to an antenna discharge unit, size of grounding conductors, location of antenna-discharge unit, connection to grounding electrodes, and requirements for the grounding electrode. See figure A.

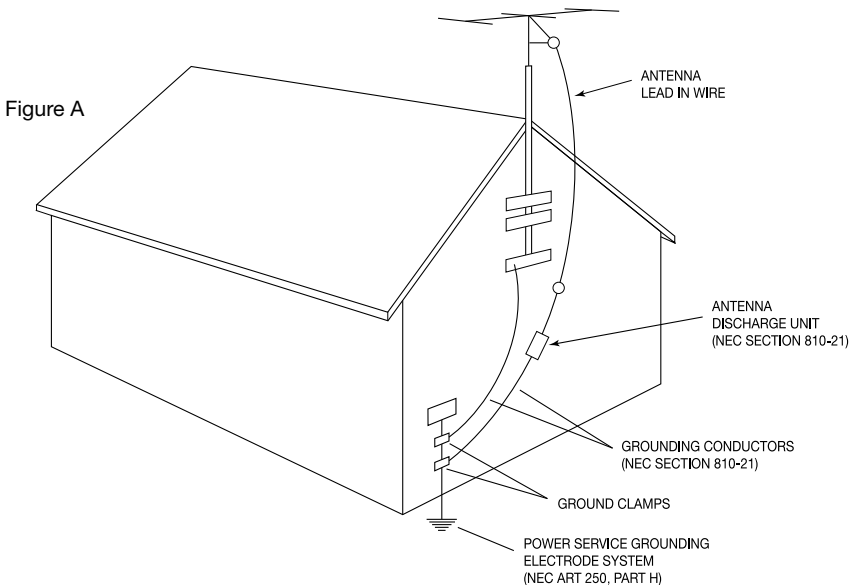

19. For added protection for this product during a lightning storm, or when it is left unattended and unused for long periods of time, unplug it from the wall outlet and disconnect the antenna or cable system. This will prevent damage to the product from lightning and power-line surges.
20. An outside antenna system should not be located in the vicinity of overhead power lines or other electric light or power circuits, or where it can fall into such power lines or circuits. When installing an outside antenna system, extreme care should be taken to keep from touching such power lines or circuits as contact with them might be fatal.
21. Operate this product only from the type of power source indicated on the rear panel. For products using an external power supply, use an exact replacement if lost or damaged. For products operating from battery power, refer to the user manual.
22. Unplug this product from the wall outlet and refer servicing to qualified service personnel under the following conditions:
  - a. When the power supply cord or plug is damaged.
  - b. If liquid has been spilled or objects have fallen into the product.
  - c. If the product has been exposed to water or rain.
  - d. If the product does not operate normally by following the operating instructions.
  - e. If the product has been dropped or damaged in any way.
  - f. When the product exhibits a distinctive change in performance.
23. If the LCD becomes cracked and damaged, do not touch the liquid.
24. Keep this product a safe distance away from naked flame, such as a lit candle.
25. Do not expose this product to splashing or dripping. Objects containing liquid, such as vases or drinking glasses, should not be placed on top of this product.
26. The recommended operating temperature range is 41° F to 104° F (5° C to 40° C).

## Model 10 Instructions

Congratulations on your purchase. We believe the Model 10 to be one of the finest FM/AM table clock radios on the market today.

We know you are eager to begin listening to your new radio, but in order to take full advantage of what your radio is capable of, please take a moment to read this owner's manual and the safety instructions. If you have any questions, please do not hesitate to contact your dealer or Tivoli Audio.

**Please save the carton and original packing should you ever need to ship your radio, as shipping damage is not covered by the factory warranty.**

On behalf of all of us, thank you for choosing Tivoli Audio, and enjoy your Model 10!

## About Tivoli Audio

Tivoli Audio was founded by Tom DeVesto with the mission of bringing simple to use, elegantly designed, high quality audio products to consumers. As CEO and head of research and development at his former company, Cambridge SoundWorks, Tom was responsible for the development of many of the best selling home entertainment and multi-media products on the market. He also held senior management positions in product development at both Advent and Kloss Video.

\*Cambridge SoundWorks is a registered trademark of Creative Labs, Singapore.

### **Packed with your NetWorks you should find one each:**

- 1 9' (2.74 m) power cord
- 1 Remote control (battery installed)
- 1 warranty registration card

Please contact your dealer or Tivoli Audio if any of these items are missing.

## Guide to Features (Front Panel):

### 1. MULTI-FUNCTION CONTROL WHEEL (TOP):

The control wheel conveniently serves many functions:

**Power:** When the Model 10 is off, press to power the unit on. When the Model 10 is on in any source, press and hold to power the unit off.

**Volume:** When the Model 10 is on in any source, rotate clockwise to increase the volume level and counter-clockwise to decrease the volume level.

**Tuning:** In FM or AM, press once and rotate clockwise to manually tune up and counter-clockwise to manually tune down. Press the control wheel again to update the display to the new station. There is no tuning function in Auxiliary. After about 6 seconds of no activity, the control wheel will default back to the volume control function.

**Source:** With the Model 10 in FM or AM, press twice to access the source menu and change sources by rotating the wheel in either direction. Press the control wheel again to switch to the new source. In Auxiliary, press the wheel only once to access and change sources. After about 6 seconds of no activity, the Model 10 will switch to the source shown.

**Snooze:** Press to engage Snooze when the alarm sounds. A  icon will show on the display when Snooze is active. The Snooze time is fixed at 7 minutes. Press again during Snooze to cancel the snooze.

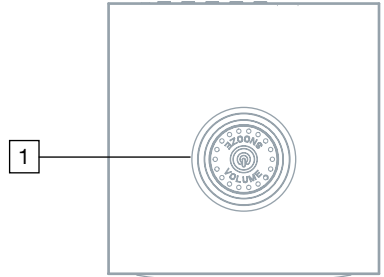

### 2. LCD:

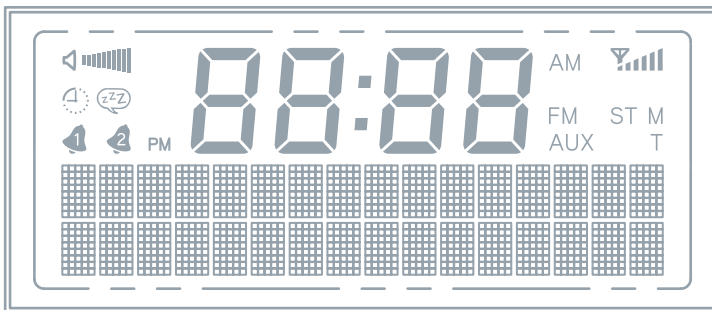

 : Volume level

 : Sleep timer

 : Snooze timer

 : Alarms 1 and 2

**PM:** PM

**88:88** (center digits): Time

 : FM/AM signal level

**AM:** AM band

**FM:** FM band

**AUX:** Auxiliary

**ST:** Stereo

**M:** Mono

**T:** Manual tuning mode

 : Back or forward in Menu

**---.---** : FM auto scan

**----** : AM auto scan





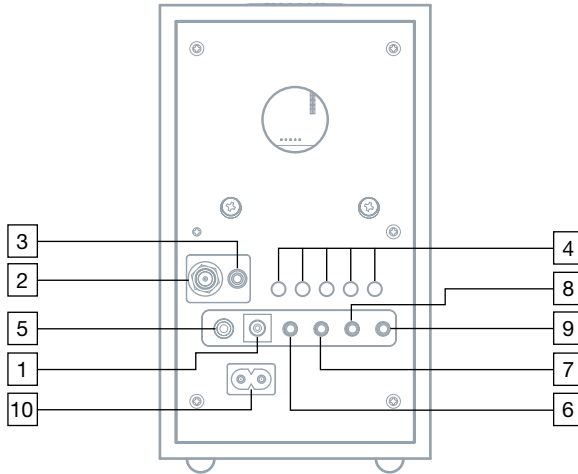

## Guide to Features (Rear Panel):



1. **12VDC/1000mA:** This input is for use with an optional 1A fused, 12VDC adapter. The adapter must be 5.5mm/2.1mm center positive.
2. **75 OHM "F" CONNECTOR:** A telescoping FM antenna is attached to this input. Adjust for best reception. For more, see the section marked "FM/AM Reception".
3. **HEADPHONE OUT:** Connect a headset (not included) to this variable stereo output for private listening. The headset will mute the primary speaker. The headset's volume is adjusted using the control wheel or the remote control. The remote's "Mono" button also affects this output. This stereo output accepts a 1/8" stereo male mini connector. Avoid using headphones at high volume levels to prevent possible hearing damage.
4. **PRESETS 1-5:** Press and hold to store the currently tuned station. Press briefly to recall the station associated with that specific preset. The preset number will be indicated on the display. There are 5 presets for the FM band and 5 presets for the AM band.
5. **R-SPR:** Connect the male RCA cable from the optional Tivoli Audio Model 10 Speaker to this female RCA output. Make sure the Stereo/Mono setting is set to Stereo by using the Mono button on the remote control.
6. **SUB OUT:** Connect the audio cable from the optional Tivoli Audio Model Subwoofer (or other compatible subwoofer) to this output. This jack accepts a 1/8" stereo male mini connector.
7. **REC OUT:** Connect a cassette deck's audio input (or other recording device) to this fixed level stereo output to record the audio. The primary speaker will not be muted when using this output. This jack accepts a 1/8" stereo male mini connector.
8. **MIX IN:** Connect the audio output of another device, such as a computer, to this input to hear the audio mixed in with the FM or AM tuner. With the Model 10 in Auxiliary mode, this input acts as a second Auxiliary input. This stereo input accepts a 1/8" stereo male mini connector. The volume level is controlled by the source device.
9. **AUX IN:** To hear audio from another device, such as Tivoli Audio's Model CD, a MP3 player, or TV, connect said device's audio output to this stereo input and change the source to Auxiliary. This stereo input accepts a 1/8" stereo male mini connector. Note you may need to adjust the volume level differently for an auxiliary device than the level used for radio listening.

- POWER CORD INPUT:** Firmly insert the included power cord. When unplugging the power cord from the wall outlet, always grasp it by the plug and not the cord. We recommend the use of a power strip with surge protection. Be sure your region's voltage is consistent with the voltage indicated on the rear panel under the power cord input. Tivoli Audio is not responsible for damaged caused by incorrect voltage.

## Guide to Features (Remote Control):

- POWER:** Press briefly to power the Model 10 on. The radio will power on to the last source used. Press to power the Model 10 off.
- MUTE/SNOOZE:** Press to mute the audio (the  icon will flash) while the unit is playing; press again or adjust the volume to restore sound. Press to mute the alarm for 7 minutes after the alarm sounds. The alarm will re-sound after 7 minutes. A  icon will show on the display when Snooze is active. The Snooze time is not adjustable.
- ALARM:** Use the   and Select buttons to adjust and set the alarms. For a complete step-by-step guide, refer to the section titled "How to set the Alarm."
- SLEEP:** Press to start the 20 minute sleep timer. The display will indicate the remaining sleep time and automatically power the radio off after 20 minutes. A small clock face  will show on the display when the Sleep timer is active. Press again to cancel the sleep timer. The amount of sleep time is not adjustable. Sleep can be activated regardless of whether the Model 10 is on or off.
- SOURCE:** Press to change sources.
- INFO:** Press repeatedly to view basic settings information.
- PRESETS 1-5:** Press and hold to store the currently tuned station. Press briefly to recall the station associated with that specific preset. The preset number will be indicated on the display. There are 5 presets for the FM band and 5 presets for the AM band.
- VOLUME +/-:** Press the + button to raise the volume level or the – button to lower the volume level. If the audio ever sounds distorted, lower the volume level to avoid damaging the speaker. Adjusting the volume while the Model 10 is muted will cancel the muting.
- ▲▼/TUNE +/-:** Press to adjust menu items. Use these same buttons to manually tune up or down when in FM or AM mode. Press and hold to move quickly through the frequencies. A "T" will show on the display to indicate manual tuning mode. It will take 2 or 3 seconds until the frequencies begin to change. Press for 1.5 seconds and release to auto scan to the next station detected. The display will show "----. --" when auto scanning in FM and "-----" when auto scanning in AM.

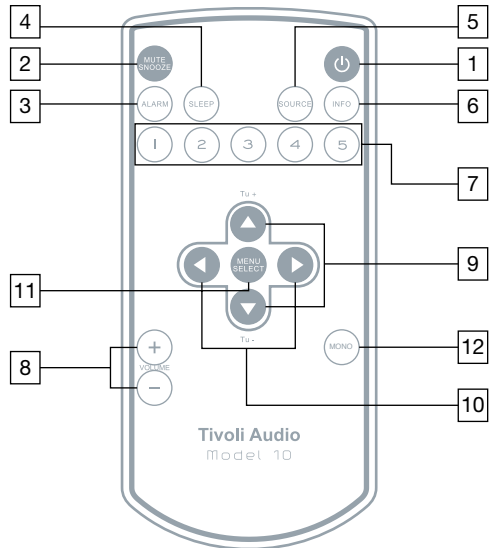

10. ◀▶: Press to navigate back or forward through the menu.
11. **MENU/SELECT:** Press to enter the main menu and press to select items within the menu. For more, see the section marked “Menu”. Some of the menu items can be accessed regardless of whether the Model 10 is on or off.
12. **MONO:** Press to change the Stereo/Mono setting. The display will show “M” for mono or “ST” for stereo. “Mono” or “Stereo” will also be one of the fields shown when pressing the Info button on the remote. This setting also affects the headphone output. For more, see the section marked “FM/AM Reception”.

## Menu:

(Press the Menu/Select button briefly. Use the ◀▶ arrow buttons to navigate through the menu pages and the ▲▼ buttons to change the items within the menu.)

1. **TREBLE:** Use ▲▼ to adjust the treble and press Select to proceed to the next menu item.
2. **BASS:** Use ▲▼ to adjust the bass and press Select to proceed to the next menu item.
3. **BALANCE:** As the balance control has no effect when the Model 10 is set to Mono, this setting should remain in the center position, except when the optional Model 10 Speaker is connected and Stereo mode is selected via the remote control’s “Mono” button. Though we still recommend the center balance setting in Stereo mode, you may use the ▲▼ buttons to adjust the balance to your liking, and press the Select button.
4. **EQ:** The equalizer acts as a Loudness control at low volume levels. Use ▲▼ to select between having the EQ on, having the EQ always off, or the EQ off until the Model 10 is turned off (when it is turned on again the EQ will be on again). Press Select to proceed to the next menu item.
5. **DISPLAY OFF:** Use the ▲▼ and Select buttons to set the display on or off. Setting the display off will turn the backlight off when the Model 10 is turned off. This may be desirable when sleeping. While the display is off, pressing a button on the remote will turn the display on for 10 seconds.
6. **BACKLIGHT:** Use ▲▼ to make the backlight brighter or dimmer.
7. **CONTRAST:** Use ▲▼ to increase or decrease the display contrast.
8. **CLOCK SET:** Use ▲▼ to set/change the hour (the hour will determine AM or PM), then press Select. Repeat this process to set/change the minutes, then press Select to proceed to the next menu item. Use ▲▼ to set the year and press Select to proceed to the next menu item. Use ▲▼ to set the month and press Select to proceed to the next menu item. Use ▲▼ to set the day and press Select to complete the process and return to the source screen.

## How to set the alarm:

Access the alarm menu by briefly pressing the Alarm button on the remote control.

9. Alarm 1 is shown first. Press the Alarm button or use the ▲▼ and Select buttons to choose between Alarm 1 and Alarm 2. Note: At any point you can navigate through the alarm menu by using the ◀▶ buttons.
10. Use the ▲▼ buttons to set/change the hour, then press Select. Repeat this process to set/change the minutes. AM/PM will automatically be determined by the hour.
11. Use the ▲▼ and Select buttons to set the alarm on or off.
12. Use the ▲▼ and Select buttons to set the alarm schedule (how often you want the alarm to wake you up).
13. Use the ▲▼ and Select buttons to set the source you wish to wake to. If you choose FM or AM, use the tune +/- buttons to tune a station, or press one of the preset buttons if you have set stations to the presets. Be sure to set a station that will be broadcasting during the time you wish to wake.
14. Lastly, use the ▲▼ buttons to set the volume level of the alarm. The alarm icon will show on the display if the alarm is set to wake
15. Repeat this process for Alarm 2 if desired.

If you make a mistake at any point in the process, press the ◀ button on the remote and begin again.

**Note:** Your settings will be saved automatically if you exit from the alarm menu at any stage. Also, if no action is taken after 10 seconds while in the alarm menu, the display will revert to its previous state and any alarm changes will be saved automatically.

**Power Loss:** Should power be lost, or the Model 10 becomes disconnected, the alarm time will be saved but the Model 10 alarm cannot sound if there is no power.

## ALARM OPTIONS:

**Alarm off:** To stop the alarm, press the Alarm or Power button on remote, or press and hold the Multi-Function Control Wheel on top of the unit.

**Alarm Quick Set:** With the Model 10 in standby, repeatedly press the alarm button briefly to toggle each alarm on or off.

**Snooze:** To activate Snooze while the alarm is sounding, press the Snooze button on the remote, or briefly press the Multi-Function Control Wheel on top of the unit. If you press the Snooze button again it will cancel snooze. **Note:** The Snooze time is not adjustable.

## **FM/AM Reception:**

The included external FM antenna will provide good reception. In strong FM signal locations, reducing the antenna's length may provide better reception. This antenna has no effect on AM reception. Another alternative is to use an optional FM dipole antenna, though an adapter might be required. Connecting your cable television's 75ohm coaxial cable to the external FM connection may also provide clear local reception, although you must usually request activation of this service through your cable company.

If you are using the Model 10 together with the optional Model 10 Speaker for stereo sound and you are listening to a noisy FM station, press the Mono button on the remote control, as this might make the station more listenable. This button has no effect on AM reception.

For the AM band, since the AM ferrite rod antenna is internal, rotate the Model 10 for best reception. An optional external wireless AM antenna may provide improved AM reception.

Buildings made with concrete, steel, or aluminum siding will hinder reception. Household appliances, electric blankets, computers, CD players, and other electronic devices can also adversely affect reception or inject noise. If you experience this, move the Model 10 further from the offending device or plug it into an electrical outlet not shared by another device. Metal surfaces may also hinder AM reception.

## **RDS/RBDS (FM band only):**

The Radio Data System transmits text data along with the audio broadcast. Not all FM stations utilize this service, thus text may not be present with some stations. For stations broadcasting RDS, the text still might not appear, or might appear scrambled if the signal is too weak. In such cases, experiment with the position of the FM antenna. Note RDS content is determined by each individual FM station.

## **Placement:**

Place the Model 10 on a flat, stable surface. For proper bass and ventilation, do not obstruct the rear bass port. The Model 10 is not video shielded and should be kept at minimum of 5" (127mm) away from a computer monitor or television set. Placement in a bookcase, cabinet, or close to walls or corners may inflate the bass, creating an unnatural sound.

## **Cleaning:**

Never use any harsh cleansers or solvents on your radio. Avoid spray-on waxes. A liquid wood polish usually yields best results.

Painting or staining the wood cabinet will void your warranty.

*An important note about the wood cabinet: The variation in color and grain are characteristics of real wood and contribute to the cabinet's natural beauty. The veneer for each cabinet is unique. As a result, the cabinet's finish may not match other Tivoli Audio products.*

*Depending on the veneer, you might also notice the wood darken over time with exposure to light. This is normal.*

## **Re-set:**

Should you need to re-set the Model 10 for any reason, unplug the power cord and plug it back in.

## Limited Warranty:

Tivoli Audio manufactures its products to very high standards and we are confident our products will perform well. Accordingly, we provide a limited warranty on this product against manufacturing defects in material and workmanship to the original owner, for a period of one year from the original date of purchase. This warranty is non-transferable.

This Limited Warranty covers the functionality of the product for its normal, intended use as specified in this Owner's Manual. It does not cover a malfunction or damage that has resulted from improper or unreasonable use or installation, faulty ancillary equipment, modifications, unauthorized repair, shipping damage or loss, abuse, accidents, use on improper voltage/current, power surges, lightning or other acts of God, excess moisture, normal wear and tear, commercial use, or purchase from unauthorized dealers. Proof of purchase as evidence the unit was purchased from an authorized dealer may be required for warranty service. **Please contact the dealer of purchase or local distributor for warranty service or repair.**

Returns of any model purchased directly from Tivoli Audio via our website, telephone, mail, or fax: must have a Return Authorization (RA) number clearly indicated on the outside of the package. An RA number can be obtained by phoning Tivoli Audio customer service (1.877.297.9479) with the product's model name, serial number, approximate date of purchase, and detailed description of the problem, or by filling out the RA form on our web site ([www.tivoliaudio.com](http://www.tivoliaudio.com)). PRODUCTS RETURNED TO TIVOLI AUDIO WITHOUT A VALID RA # WILL BE RETURNED UNOPENED TO THE SENDER.

Please refrain from opening this product or taking it apart as doing so will void this Limited Warranty. There are no user serviceable parts inside. Tivoli Audio will not pay for costs incurred due to correction of reception problems, elimination of externally generated static/noise, loss of time, inconvenience, loss of use of product, or damage caused by improper use of this product.

In the event the product is returned during the warranty term and is eligible for service under this Limited Warranty, we will repair or replace any defective parts within a reasonable period of time and free of charge.

THIS LIMITED WARRANTY GIVES YOU SPECIFIC LEGAL RIGHTS SUBJECT TO SPECIFIED CONDITIONS. YOU MAY ALSO HAVE OTHER LEGAL RIGHTS WHICH APPLY TO THE PRODUCT YOU HAVE ACQUIRED. SOME PLACES DO NOT ALLOW THE EXCLUSION, RESTRICTION, OR MODIFICATION OF CERTAIN IMPLIED RIGHTS OR THEIR EFFECT. IN THOSE SITUATIONS THIS LIMITED WARRANTY WILL ONLY APPLY TO THE EXTENT THAT THE APPLICABLE LAW ALLOWS.

The provisions of the Limited Warranty are in lieu of any other warranties or conditions, except those provided by law. This Limited Warranty does not affect any legal rights provided to you by law and does not preclude any remedy you may have under law.

In states where liability limits are not precluded by statute, the maximum liability of Tivoli Audio shall not exceed the purchase price paid by you for the product. In states where limitations of liability are precluded by law, Tivoli Audio shall be liable for no more than the direct damages for bodily injury, and/or real or personal property arising from the negligence of Tivoli Audio.

Where not prohibited by law, Tivoli Audio shall not be liable for special, incidental, consequential, or indirect damages. Some places do not allow limitations on the exclusion or limitation of relief, special, incidental, consequential or indirect damages, or the limitation of liability to specified amounts, so the above limitations or exclusions may not apply to you.

This Limited Warranty is void if the label bearing the serial number has been removed or defaced.

For service outside the USA, please contact your local distributor.

If you purchased an extended service contract from your dealer and service is required after the term of this Limited Warranty has expired, please contact your extended service contract provider to obtain service.

For your convenience, you may register your product for warranty service online at our website, [www.tivoliaudio.com](http://www.tivoliaudio.com). There is no legal obligation for you to provide personal information. However, such information allows us to maintain a record of the Tivoli Audio products acquired by you and better understand the purchasers of our products. The information collected will be used for marketing purposes by Tivoli Audio and, where permitted, to contact you in relation to the products you have acquired or other products which might be of interest to you from Tivoli Audio or other companies. The information that you provide may be processed in another country.

**Please visit the Tivoli Audio FAQ section at [www.tivoliaudio.com](http://www.tivoliaudio.com) prior to any request for warranty service as information available there may answer your questions or concerns.**

You may email questions to us at [mail@tivoliaudio.com](mailto:mail@tivoliaudio.com)

For your convenience, you may register your product for warranty coverage on-line at [www.tivoliaudio.com](http://www.tivoliaudio.com).

## Specifications:

<b>Model:</b>	Tivoli Audio Model 10™
<b>Type:</b>	AM/FM clock radio
<b>Drivers:</b>	3" full range
<b>Receiving bands:</b>	FM: 87.5-107.9MHz AM: 520-1710, 10kHz step (522-1629, 9kHz step) (Receiving ranges vary by region)
<b>FM De-Emphasis:</b>	50uSec or 75uSec (depending upon region)
<b>Dimensions:</b>	7.95"H x 4.61"W x 4.61"D (202mm H x 117mm W x 117mm D)
<b>Weight:</b>	3.5 lbs. (1.58 kg)

All specifications subject to change without notice.

Tivoli Audio reserves the right to make product changes without notice.

Tivoli Audio, the Tivoli Audio logo, the Model 10, and the Model 10 Speaker are trademarks of Tivoli Audio, LLC.

This manual was written by Peter Skiera and cannot be reproduced in whole or in part without the permission of Tivoli Audio. The information included in this owner's manual was accurate at the time of printing. Tivoli Audio shall not be held liable for operational, technical, or editorial errors/omissions. Visit our web site for the latest version of user manuals.

**For more information about other exciting products from Tivoli Audio, please visit our website or contact us directly:**

Tivoli Audio, LLC  
Seaport Center  
70 Fargo Street, Suite 900  
Boston, MA 02210 USA  
1.877.297.9479  
[www.tivoliaudio.com](http://www.tivoliaudio.com)  
[help@tivoliaudio.com](mailto:help@tivoliaudio.com)